

# Akhas

Korkuluk & Metal Ürünleri

## Gerçek 304 Kalite Ürünlerde Böyle Fiyatlar Ne Görüldü, Ne Duyuldu !

### Paslanmaz Çelik Aksesuarlar



### Paslanmaz Çelik Patent Dirsekler



### Paslanmaz Çelik Borular



'den başlayan miktarlı fiyatlarla..

Bu broşürde gördüğünüz ürünlerimiz, ürettiklerimizin sadece bir kısmıdır.  
Detaylı kataloğumuzu web sayfamızdan inceleyebilirsiniz.

# Yaz Kampanyası 2/09



Yeni  
ecoline  
sezisi

### KÜRE VE KÜRE YÜZÜKLER

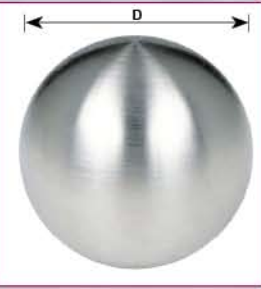

3 mm  
Montaj  
Deligi ile

KÜRE			
øD mm	Ürün Kodu	TL / Adet	
		≤ 9	≥ 10
40	1045-40-E	3,49	3,29



304  
Kalite

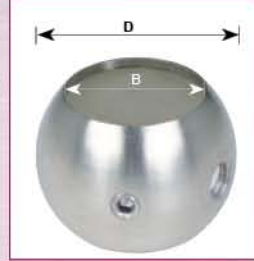

KÜRE YÜZÜK BORU TUTUCU				
øB mm	øD mm	Ürün Kodu	TL / Adet	
			≤ 9	≥ 10
26,9	40	1058-27-E	3,99	3,79
32	45	1058-32-E	4,69	4,39
48,3	60	1058-48-E	8,19	7,79
50,8	60	1058-51-E	8,49	7,99

“ecoline”



Uygun  
Fiyat

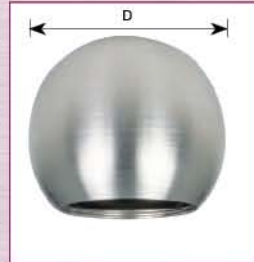

KÜRE KAPAK				
øB mm	ø D mm	Ürün Kodu	TL / Adet	
			≤ 9	≥ 10
26,9	40	1046-27-E	3,49	3,29
32	45	1046-32-E	4,19	3,99
48,3	60	1046-48-E	7,69	7,49
50,8	60	1046-51-E	7,89	7,69



“ecoline”



TOPUZ				
Kullanıldığı Boru		Ürün Kodu	TL / Adet	
Çap	Et Kalınlığı		≤ 9	≥ 10
32	1,5	1048-32-E	9,99	9,49
42,4	2,0	1048-42-E	11,99	11,49

### BORU KAPAKLARI

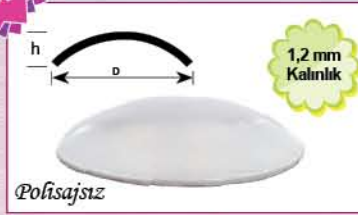

1,2 mm  
Kalınlık

Polisajsız

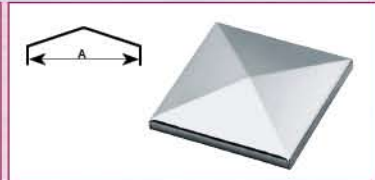

PROFİL KAPAĞI		
A / mm	Ürün Kodu	TL/Adet
30 x 30	1660-3030	1,56
30 x 40	1660-3040	2,09
40 x 40	1660-4040	2,49
50 x 50	1660-5050	2,79
60 x 60	1660-6060	3,19
80 x 80	1660-8080	3,89

### OVAL BORU KAPAĞI

øD mm	h mm	Ürün Kodu	TL / Adet
16	4	1200-16-E	0,27
42,4	9	1200-42-E	0,46
50,8	10	1200-51-E	0,54



“ecoline”

Ürün Kodu 1009-xx-E



“premium”

Ürün Kodu 1009-xx-G

### BORU KAPAĞI-İÇE GEÇME

Kullanıldığı Boru		Ürün Kodu	TL / Adet	
Çap mm	Et Kalınlığı mm		≤ 49	≥ 50
12	1,2	1009-1212	0,89	0,79
16	1,5	1009-1615	0,99	0,89
32	1,5	1009-3215	1,89	1,79
32	1,5	1009-3215-G	4,69	4,39
50,8	1,5	1009-51-E	2,19	1,99



“ecoline”



### BORU KAPAĞI-ÜSTE GEÇME

Boru Çapı	Ürün Kodu	TL / Adet	
		≤ 99	≥ 100
16	1018-16-E	0,69	0,64
42,4	1018-42-E	0,79	0,74
48,3	1018-48-E	0,94	0,89
50,8	1018-51-E	0,99	0,94



Ürün Kodu  
25100

Alman Devi WS-Plast'tan  
Emsalsiz Ürün!

Paslanmaz Çelik  
Yüzey Temizleme ve  
Bakım Spreyi

Mat ve parlak paslanmaz çelik yüzeyleri temizlemek amacıyla kullanılır. Parmak izi ve yağ lekesi kirlerini kolayca çıkarır. Yüzeyde yeniden kirlenmeye karşı ince bir koruyucu film tabakası bırakır. Alo Sipariş 0312 385 48 06

Bu Ürünler Sainnel Polisağ malzeme üzerinden fiyatlandırılmıştır.



**AK INOX**



1  
Montaj Pulu Boruya Monte Edilir.

2  
Küpeşte Ayağı Vida ile Monte Edilir.

Satineli veya Parlak

## KÜPEŞTE MAFSALLAR

### KÜPEŞTE MAFSAL TAKIMI

Kullanıldığı Dikme Borusu-øB	Ürün Kodu	TL / Adet	≤ 99	≥ 100
32 mm	1267-32-E	3,99	3,99	
38 mm	1267-38-E	3,79	3,49	
42,4 mm	1267-42-E	3,99	3,69	
32 mm	1267-32-O-E	3,89	3,29	
38 mm	1267-38-O-E	3,69	3,39	
42,4 mm	1267-42-O-E	3,89	3,59	

Küpeşte Mafsalları Takımı, küpeşte ayağı ve dikme boru şapkasından oluşur. Montaj pulu ve vidası takıma dahil değildir.

### MAFSAL MONTAJ PULU

Kullanıldığı Dikme Borusu	Malzeme	Ürün Kodu	TL / Adet	≤ 49	≥ 50
32 mm	Paslanmaz Çelik	1267-MP-32	0,49	0,44	
	Galvanizli Çelik	1267-VMP-32	0,29	0,24	
38 mm	Paslanmaz Çelik	1267-MP-38	0,55	0,49	
	Galvanizli Çelik	1267-VMP-38	0,35	0,31	
42,4 mm	Paslanmaz Çelik	1267-MP-42	0,59	0,54	
	Galvanizli Çelik	1267-VMP-42	0,39	0,34	
M6x30 Vida	Paslanmaz Çelik	S7991-6-30	0,13	0,12	
	Galvanizli Çelik	V7991-6-30	0,06	0,05	

Küpeşte mafsalları takımının montaj vidası tercihi, paslanmaz çelik veya galvanizli çelik olarak kullanılcıya bırakılmıştır. Pul ve vida kullanımında paslanmaz çelik ürünler tavsiye edilir.

## KÜPEŞTE MONTAJ KOL VE ÇUBUKLARI

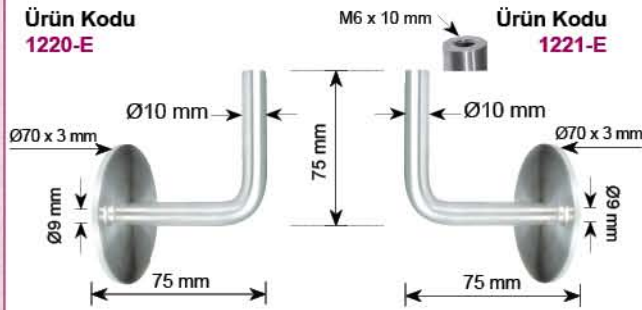

Ürün Kodu	TL / Adet	≤ 99	≥ 100
1220-E	4,99	4,49	
1221-E	5,39	4,99	
1229-G-E	3,29	2,99	

### KÜPEŞTE MONTAJ TABLASI

øD mm	Ürün Kodu	TL / Adet	≤ 99	≥ 100
32-34	1280	1,49	1,39	
38-43	1281	1,49	1,39	
48-51	1282	1,49	1,39	

### Örnek Uygulamalar



L / mm	Ürün Kodu	TL / Adet	≤ 99	≥ 100
65	1292-E	2,09	1,99	
100	1293-E	2,29	2,19	

## ÇUBUK TUTUCULAR

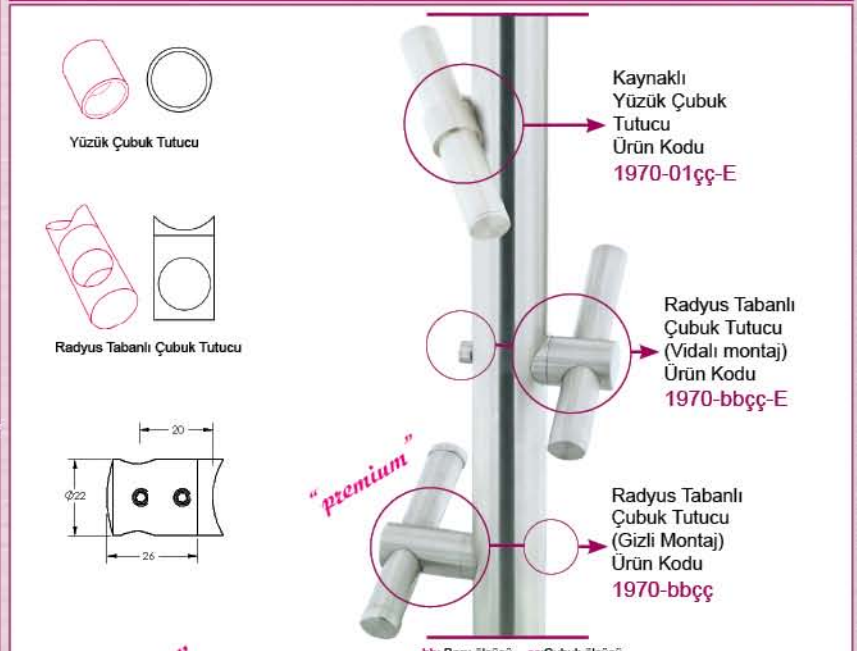

Montaj Edildiği Boru/mm	Kullanıldığı Çubuk / mm	Ürün Kodu	TL / Adet	≤ 99	≥ 100
Tüm Borular	ø 12	1970-0112-E	0,89	0,84	
Tüm Borular	ø 16	1970-0116-E	0,99	0,94	
ø 32-34	ø 12	1970-3312-E	2,99	2,89	
ø 32-34	ø 16	1970-3316-E	2,99	2,89	
ø 38-43	ø 12	1970-4212-E	2,99	2,89	
ø 38-43	ø 16	1970-4216-E	2,99	2,89	
ø 32-34	ø 12	1970-3312	3,79	3,49	
ø 32-34	ø 16	1970-3316	3,79	3,49	
ø 38-43	ø 12	1970-4212	3,79	3,49	
ø 38-43	ø 16	1970-4216	3,79	3,49	



## CAM TUTUCULAR

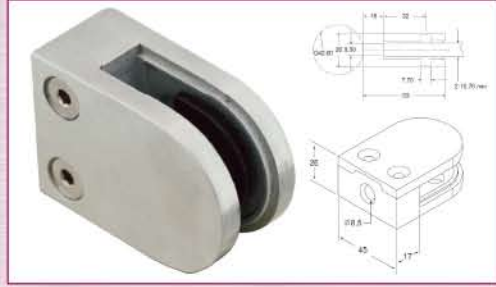
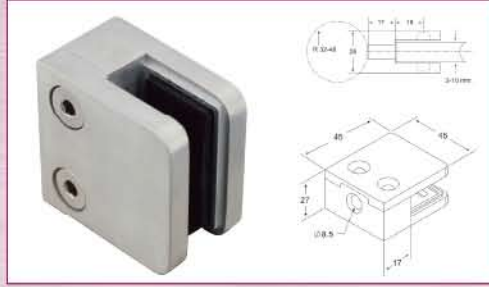
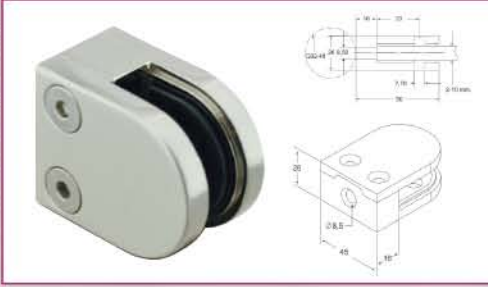

Form-1				
Yüzey	Taban	Ürün Kodu	TL / Adet	TL / Adet
			≤ 99	≥ 100
Zamak	Düz	1811-G	4,49	4,19
	ø32-34	1811-R32	4,49	4,19
	ø38-43	1811-R42	4,49	4,19
	ø48-51	1811-R48	4,49	4,19
Inoks Görünüm	Düz	1819-G	4,99	4,69
	ø32-34	1819-R32	4,99	4,69
	ø38-43	1819-R42	4,99	4,69
	ø48-51	1819-R48	4,99	4,69
Inoks 304	Düz	1841-G	8,49	7,99
	ø32-34	1841-R32	8,49	7,99
	ø38-43	1841-R42	8,49	7,99
	ø48-51	1841-R48	8,49	7,99

Form-2				
Yüzey	Taban	Ürün Kodu	TL / Adet	TL / Adet
			≤ 99	≥ 100
Zamak	Düz	1821-G	4,69	4,39
	ø32-34	1821-R32	4,69	4,39
	ø38-43	1821-R42	4,69	4,39
	ø48-51	1821-R48	4,69	4,39
Inoks Görünüm	Düz	1829-G	5,49	5,29
	ø32-34	1829-R32	5,49	5,29
	ø38-43	1829-R42	5,49	5,29
	ø48-51	1829-R48	5,49	5,29
Inoks 304	Düz	1851-G	8,99	8,49
	ø32-34	1851-R32	8,99	8,49
	ø38-43	1851-R42	8,99	8,49
	ø48-51	1851-R48	8,99	8,49

Form-3				
Yüzey	Taban	Ürün Kodu	TL / Adet	TL / Adet
			≤ 99	≥ 100
Zamak	Düz	1831-G	4,99	4,69
	ø32-34	1831-R32	4,99	4,69
	ø38-43	1831-R42	4,99	4,69
	ø48-51	1831-R48	4,99	4,69
Inoks Görünüm	Düz	1839-G	5,99	5,79
	ø32-34	1839-R32	5,99	5,79
	ø38-43	1839-R42	5,99	5,79
	ø48-51	1839-R48	5,99	5,79
Inoks 304	Düz	1861-G	9,99	9,69
	ø32-34	1861-R32	9,99	9,69
	ø38-43	1861-R42	9,99	9,69
	ø48-51	1861-R48	9,99	9,69

Ürün Kodu  
1712571

İsviçre'den **Rozet montajlarınızda MUNGO'nun boşluk dolduran yüksek kaliteli Poliüretan yapıştırıcısını deneyiniz !..**

Detaylı bilgi Yardımcı Malzemeler sayfasında...

## ROZETLER

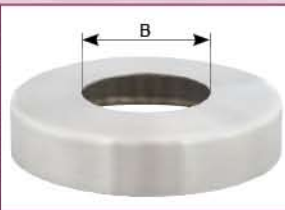

ROZET ø105X22 mm		
Boru B/mm	Ürün Kodu	TL/Adet
32	1216-32-E	2,79
33,7	1216-34-E	2,79
42,4	1216-42-E	2,79
48,3	1216-48-E	2,79
50,8	1216-51-E	2,79

ROZET ø75X12 mm		
Boru B/mm	Ürün Kodu	TL/Adet
12	1206-12-E	1,99
16	1206-16-E	1,99
32	1206-32-E	1,99
38	1206-38-E	1,99
42,4	1206-42-E	1,99

ROZET ø75X22 mm		
Boru B/mm	Ürün Kodu	TL/Adet
32	1210-32-E	2,39
33,7	1210-33-E	2,39
38	1210-38-E	2,39
42,4	1210-42-E	2,39
48,3	1210-48-E	2,39

ROZET ø75X24 mm		
Boru B/mm	Ürün Kodu	TL/Adet
12	1201-12-E	3,49
16	1201-16-E	3,49
32	1201-32-E	3,49
33,7	1201-34-E	3,49
38	1201-38-E	3,49

ROZET ø67X12 mm		
Boru B/mm	Ürün Kodu	TL/Adet
10	1205-10-E	1,99
32	1205-32-E	1,99
38	1205-38-E	1,99
42,4	1205-42-E	1,99
50,8	1205-51-E	1,99



### AK INOX

### MONTAJ PULLARI



D x s / mm	Ürün Kodu	TL / Adet	
		≤ 99	≥ 100
80 x 4	1122-E	2,99	2,89
100 x 4	1123-E	3,39	3,29
70 x 3	1130-E	2,69	2,49
80 x 4	1131-32-E	3,29	3,19
100 x 4	1131-42-E	3,29	3,19

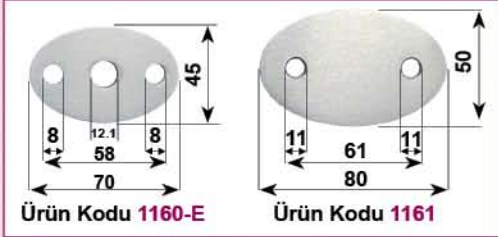
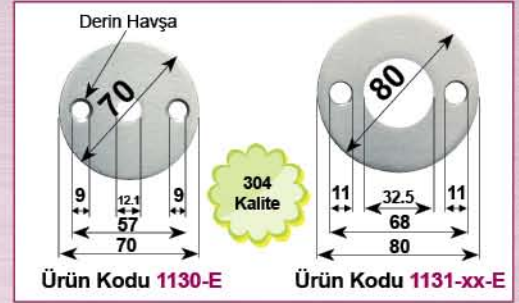

B x h x s / mm	Ürün Kodu	TL / Adet	
		≤ 99	≥ 100
70 x 45 x 3	1160-E	2,99	2,89
80 x 50 x 4	1161	2,99	2,89
100 x 50 x 4	1140-E	2,99	2,69
120 x 60 x 4	1141	3,59	3,29

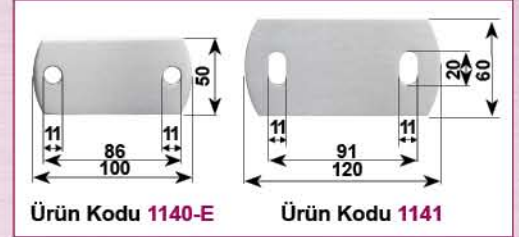

### AK INOX

### ANKRAJ MALZEMELERİ



Dikkat! Uygulama yerlerinde montaj puluna kaynak yapmak zor iştir. Sizde AKBAŞ Montaj çözümleri kullanın, işinizi kolaylaştırın.

Dikme borularının mukavemetini arttırmak için tavsiyemiz ankrāj montaj altlıkları

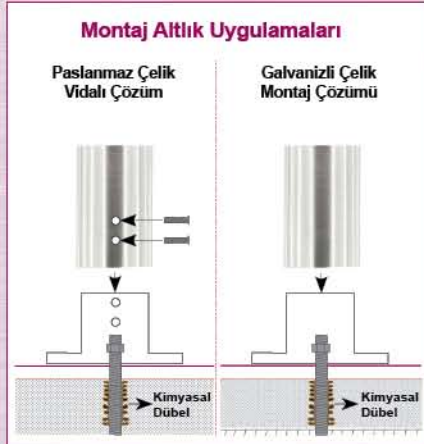

## Beton ve tuğla içi montajlarınızda tavsiyemiz MUNGO kimyasal dübelleri !..

Ürün Kodu 1710028



Uygulamalarda en iyi sonuç; MUNGO Kartuş, Dübel ve Elekleri ile birlikte elde edilmektedir.



Detaylı bilgi Yardımcı Malzemeler sayfasında...



### ZEMİN PULLARI

AK INOX

**Yeni  
Ürün**

- Ürün Özellikleri**
1. Tırnaklı iç katmanı sayesinde boruya tam oturarak kayma yapmaz.
  2. Kolay kaynak yapma özelliği ile zamanınız boşa gitmez.
  3. Sağlam ve düzgün bir montaj imkanı sağlar.



D x s / mm	Ürün Kodu	TL / Adet	
		≤ 99	≥ 100
70 x 4	1128-32-E	3,79	3,69
100 x 4	1128-43-E	4,29	4,19
100 x 4	1128-51-E	4,29	4,19

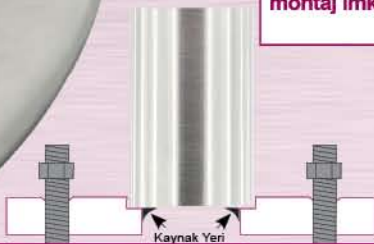

## Pul ve Aksesuar montajlarında DIN normlu MUNGO çelik dübellerini deneyiniz !..

İsviçre'den ithal

Galvanizli Çelik Dübelleri

316 Kalite Paslanmaz Çelik Dübelleri

Tuğla Montaj Uygulamalarında İdeal

Kimyasal Dübel Eleklere



Detaylı bilgi Yardımcı Malzemeler sayfasında...



### DİKME MONTAJ AKSESUARLARI

AK INOX



Ürün Kodu 1960-xx-E



Boru mm	Ürün Kodu	TL / Adet.
32	1960-32-E	12,99
38	1960-38-E	12,99
42,4	1960-42-E	12,99
32	1961-32-E	12,99
38	1961-38-E	12,99
42,4	1961-42-E	12,99



Ürün Kodu 1961-xx-E



Ürün Kodu 1962-xx-E



Boru mm	Ürün Kodu	TL / Adet.
32	1962-32-E	17,99
38	1962-38-E	17,99
42,4	1962-42-E	17,99
32	1963-32-E	11,99
38	1963-38-E	12,99
42,4	1963-42-E	13,99

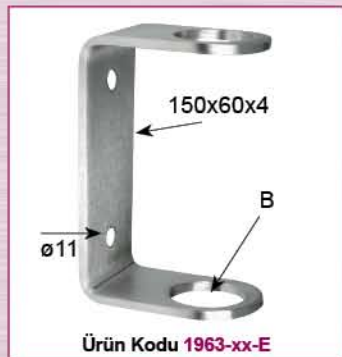

Ürün Kodu 1963-xx-E

*"ecoline"* AK INOX



**AK INOX**

**KAPI KOLLARI**

Yeni  
ecoline  
serisi

12,69  
TL / Takım

140 x 60 mm  
Ürün Kodu 1700



12,39  
TL / Takım

140 x 60 mm  
Ürün Kodu 1701



11,49  
TL / Takım

140 x 60 mm  
Ürün Kodu 1702



12,49  
TL / Takım

140 x 60 mm  
Ürün Kodu 1703



12,99  
TL / Takım

140 x 60 mm  
Ürün Kodu 1704



12,29  
TL / Takım

140 x 60 mm  
Ürün Kodu 1707



Kapı Kolları  
304 kalite paslanmaz çelik  
malzemeden üretilmiştir.

320 kum  
satineli polisaj



Takımda neler var?

- 2 Adet Kol
- 2 Adet Kol Rozeti
- 2 Adet Kilit Rozeti
- Montaj Vidaları

140 x 60 mm  
Ürün Kodu 1712



12,29  
TL / Takım

140 x 60 mm  
Ürün Kodu 1715



12,49  
TL / Takım

140 x 60 mm  
Ürün Kodu 1714



13,99  
TL / Takım

140 x 60 mm  
Ürün Kodu 1713



12,29  
TL / Takım

140 x 60 mm  
Ürün Kodu 1716



12,29  
TL / Takım

"premium"  
Satineli

Dolu  
Malzeme

140 x 60 mm  
Ürün Kodu 1708



19,99  
TL / Takım

140 x 60 mm  
Ürün Kodu 1709



29,99  
TL / Takım

140 x 60 mm  
Ürün Kodu 1705



34,99  
TL / Takım

**ROZETLER**

1,39  
TL / Adet



26x65 mm  
Ürün Kodu 1755-PZ

1,39  
TL / Adet



26x65 mm  
Ürün Kodu 1755-BB

1,39  
TL / Adet



26x65 mm  
Ürün Kodu 1755

+5,99  
TL / Takım

ø 55 mm  
Ürün Kodu 1750-WC



1,49  
TL / Adet



ø 55 mm  
Ürün Kodu 1750-PZ

1,49  
TL / Adet



ø 55 mm  
Ürün Kodu 1750-BB

1,49  
TL / Adet













ø 55 mm  
Ürün Kodu 1750



### DİZAYN ÇUBUKLAR

AK INOX

<p>9,99 TL / Adet</p>  <p>Ürün Kodu <b>1500-E</b> 40 x 40 mm</p>	<p>12,99 TL / Adet</p>  <p>Ürün Kodu <b>1501-E</b> 40 x 600 mm</p>	<p>9,99 TL / Adet</p>  <p>Ürün Kodu <b>1523-E</b> 30 x 70 mm</p>	<p>14,99 TL / Adet</p>  <p>Ürün Kodu <b>1523-D-E</b> 30 x 600 mm</p>	<p>9,99 TL / Adet</p>  <p>Ürün Kodu <b>1524-E</b> 30 x 70 mm</p>	<p>14,99 TL / Adet</p>  <p>Ürün Kodu <b>1524-D-E</b> 30 x 600 mm</p>	<p>15,99 TL / Adet</p>  <p>Ürün Kodu <b>1502-E</b> 55 x 900 mm</p>	<p>19,99 TL / Adet</p>  <p>Ürün Kodu <b>1503-E</b> 105 x 600 mm</p>	<p>29,99 TL / Adet</p>  <p>Ürün Kodu <b>1512-E</b> 150 x 550 mm</p>	<p>39,99 TL / Adet</p>  <p>Ürün Kodu <b>1513-E</b> 150 x 550 mm</p>
--	--	--	--	--	--	--	---	---	---

Boy: 800 mm

Özel Sipariş ile Üretilir.



Çubuk Sonlandırıcı Motif  
ø 24 x 18 mm



Delik ø / mm	Ürün Kodu	TL/Adet
10,2	1982-10	2,99
12,2	1982-12	2,99
14,2	1982-14	2,99
16	1982-16	2,99



**Dizayn çubuklarımızın kolay montaj özelliği sayesinde kısa sürede kendi korkuluğunuzu oluşturun hem zamandan kazanın, hem paranız cebinizde kalsın...**

AK INOX

### ANADOLU MODELİ

AK INOX



Uygun Fiyatlı Model

11,99  
€/ m.tül

'den başlayan fiyatlarla

#### MALZEME LİSTESİ

Sıra	Malzeme Adı
1	Küpeşte Borusu-42,4x1,5mm
2	Küpeşte Mafsalları Takımı
3	Dikme Borusu-32x1,5mm
4	Yatay Boru-16x1,2mm
5	Üst Geçme Kapak
6	Rozet-67x12mm
7	Montaj Takımı

Not: Fiyatlarımız metretül malzeme olarak hesaplanmıştır Montaj hariçtir.

Çocuklarınızın güvenle tutunacakları korkuluklar için; korkuluk aralıklarını 12cm den daha fazla yapmayınız!

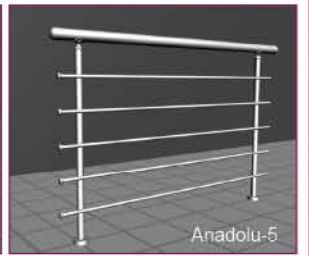
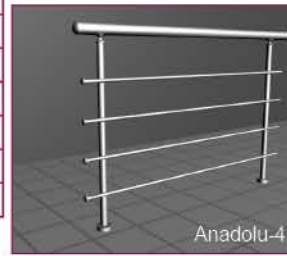



## AK INOX

## SİNOP MODELİ

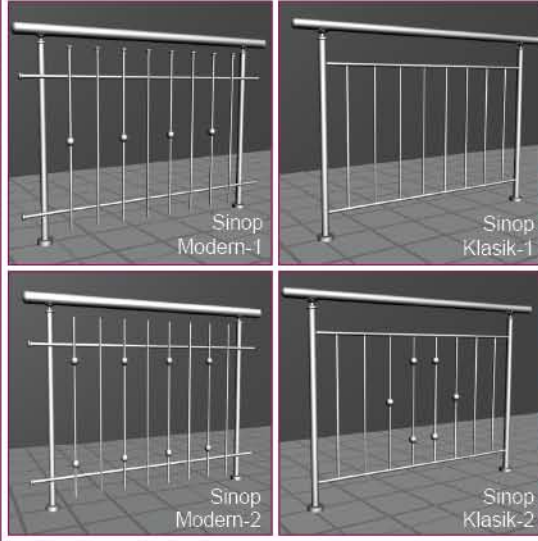

**14,99**  
€ / m.tül

'den başlayan fiyatlarla

### MALZEME LİSTESİ

Sıra	Malzeme Adı
1	Küpeşte Borusu-42,4x1,5mm
2	Küpeşte Mafsal Takımı
3	Dikme Borusu-32x1,5mm
4	Dikey Çubuklar
5	Boru Kapağı-Üste Geçme
6	Rozet-67x12mm
7	Montaj Takımı

Not: Fiyatlarımız metretül malzeme olarak hesaplanmıştır Montaj hariçtir.



Sinop Klasik-1

## AK INOX

## ANTALYA MODELİ

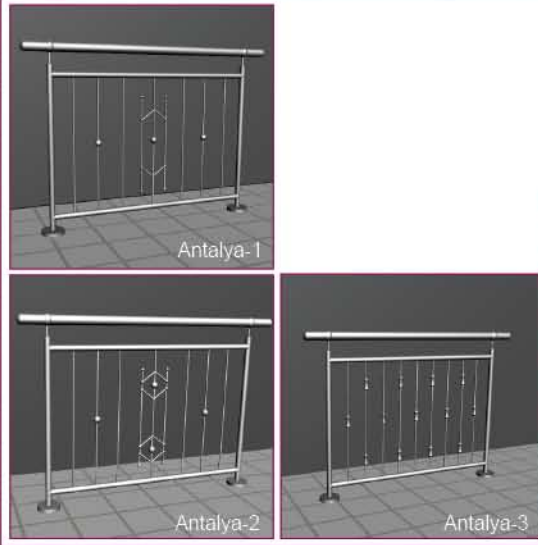

**32,99**  
€ / m.tül

'den başlayan fiyatlarla

### MALZEME LİSTESİ

Sıra	Malzeme Adı
1	Küpeşte Borusu-50,8x1,5mm
2	Küpeşte Mafsal Takımı
3	Dikme Borusu-32x1,5mm
4	Dikey Dizayn Çubuklar
5	Boru Kapağı-Üste Geçme
6	Rozet-67x12mm
7	Montaj Takımı

Not: Fiyatlarımız metretül malzeme olarak hesaplanmıştır Montaj hariçtir.

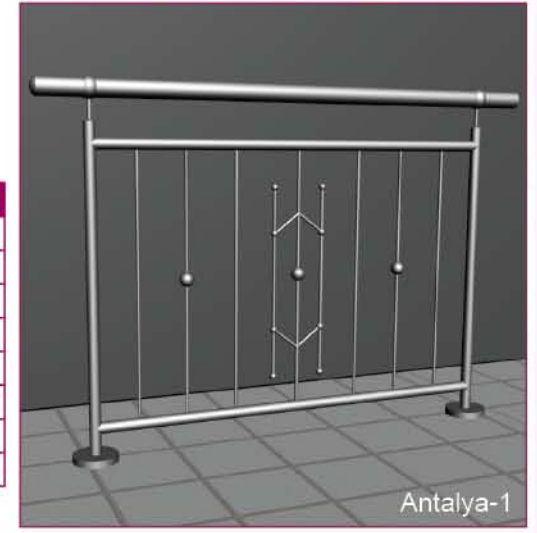

Antalya-1

## AK INOX

## GEMİ MODELİ (GERDİRME SİSTEMLİ)

### Saplamalı Terminal (Setskur Sıkıştırılmalı)

**36,99**  
€ / m.tül

'den başlayan fiyatlarla

### MALZEME LİSTESİ

Sıra	Malzeme Adı
1	Küpeşte Borusu-50,8x1,5mm
2	Küpeşte Mafsal Takımı
3	Dikme Borusu-42,4x1,5mm
4	Saplamalı Terminal
5	4 mm Pas. Çelik Halat (7x19)
6	Topuz
7	Rozet-67x12mm
8	Montaj Takımı

Not: Fiyatlarımız metretül malzeme olarak hesaplanmıştır Montaj hariçtir.

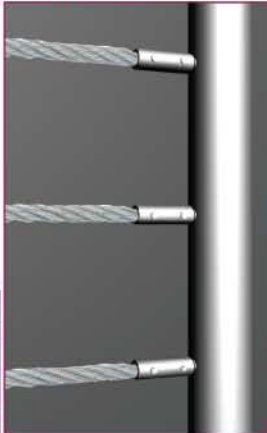
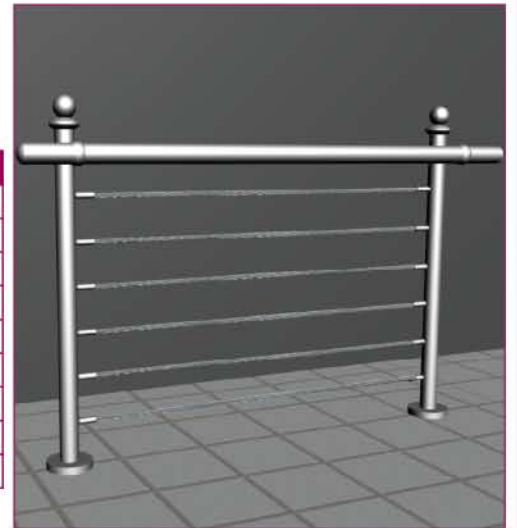

Kullanılan Tel	Ürün Kodu	TL / Adet
2	1461-8	2,85
3	1461-10	3,49
4	1461-12	3,99



### GAZİANTEP MODELİ

AK INOX

47,49  
€/m.tül

'den başlayan fiyatlarla



Gaziantep-1

#### MALZEME LİSTESİ

Sıra	Malzeme Adı
1	Küpeşte Borusu-50,8x1,5mm
2	Küpeşte Mafsallı Takımı
3	Dikme Borusu-32x1,5mm
4	Yatay Borular-16x1,2mm
5	Dikey Dizayn Çubuklar
6	Boru Kapakları
7	Rozet-67x12mm
8	Montaj Takımı

Not: Fiyatlarımız metretül malzeme olarak hesaplanmıştır Montaj hariçtir.



Gaziantep-2

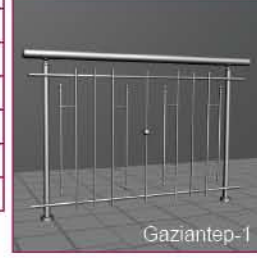

Gaziantep-1



Gaziantep-3

### SAYDAM MODEL

AK INOX

15,99  
€/m.tül

'den başlayan fiyatlarla



#### MALZEME LİSTESİ

Sıra	Malzeme Adı
1	Küpeşte Borusu-42,4x1,5mm
2	Küpeşte Mafsallı Takımı
3	Dikme Borusu-32x1,5mm
4	Boru Kapakları
5	Cam Tutucuları*
6	Rozet-67x12mm
7	Montaj Takımı

Not: Fiyatlarımız metretül malzeme olarak hesaplanmıştır Montaj hariçtir.

\* Fiyatlarımıza Cam dahil edilmemiştir.

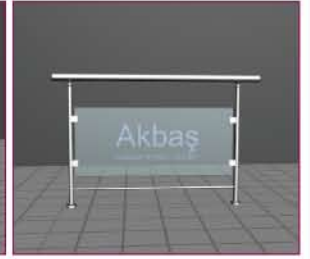
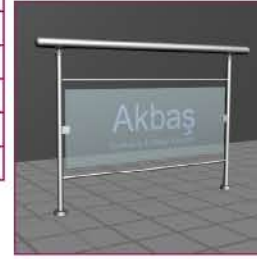
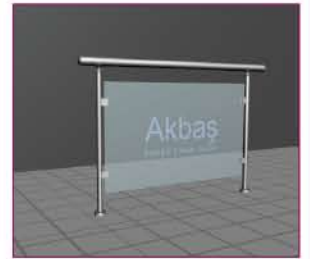

### MASA VE BROŞÜRLÜK MODELLERİ

AK INOX



Fiyatlar için sorunuz...